

Pacific Antenna Easy Audio Bandpass Filter Kit

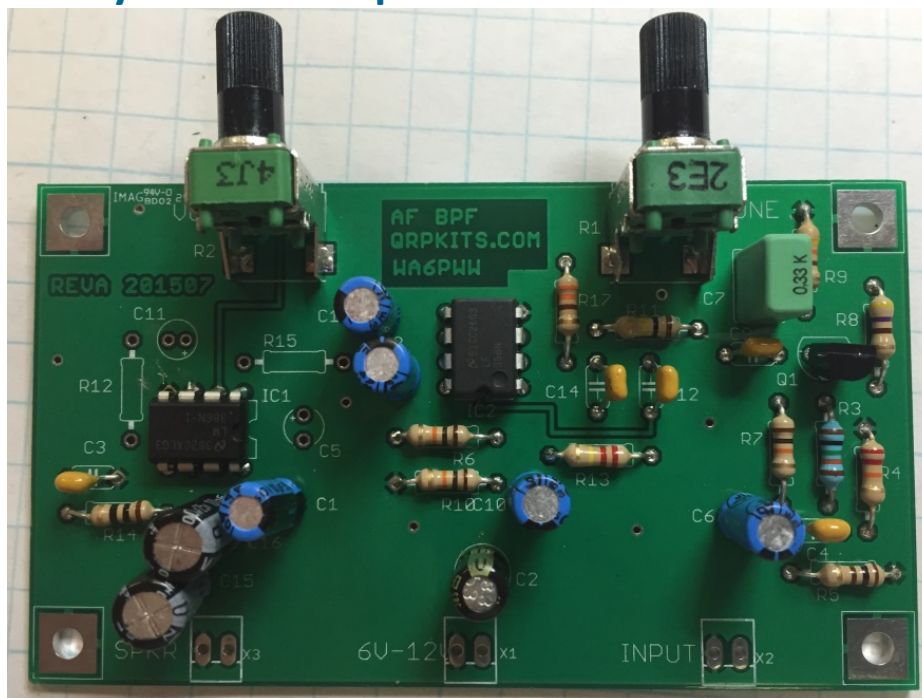

Description and Specifications

The Audio Frequency Band Pass Filter kit from qrpkits.com provides A basic audio filter kit .

Incorporates a transistor preamp, op-amp based filter and an LM386 audio amplifier to drive headphones or speaker.

Has a peak in audio response that is tunable from approximately 300Hz to 2Khz

Has a bandwidth of approximately 500Hz.

Designed to provide improved audio filtering and amplification to CW reception or other devices that may not have sufficiently narrow bandwidth.

The kit may be powered from 9-12Vdc.

Support

PACIFIC ANTENNA

QRP KITS.COM

qrpkits.com@gmail.com

Tools Needed

- Temperature Controlled Soldering Station with small tip or 15-35 watt soldering iron with small tip.
- Solder 60/40 or 63/37 Tin-Lead
- Small Diagonal Cutters
- Small Needle Nose Pliers
- Pencil, Pen, and/or Highlighter
- BRIGHT work light

Optional

- Magnifying headpiece or lighted magnifying glass.
- Multi-meter
- Solder Sucker or Solder Wick
- Small multi-blade Screw Driver
- Knife or Wire Stripper
- Small Ruler
- Cookie Sheet to build in and keep parts from jumping onto the floor.

Construction Techniques

- There is no need to print out the whole assembly manual unless you want a copy. Print the Parts List and Schematic (last two pages) then view the rest of the manual on a computer, laptop, or tablet.
- The Parts List has columns for inventory and construction.
- Please take time to inventory the parts before starting. Report any shortages to QRPKITS.com (In many cases it may be faster and cheaper to pull a replacement from your parts supply, but please let us know if we missed something.)
- There is no need to print out the whole assembly manual unless you want a copy. Print the
- Pre-sorting the resistors and capacitors can speed up the assembly and reduce mistakes.
- You can insert several parts at a time onto the board. When you insert a part bend the leads over slightly to hold the part in place, then solder all at the same time. Clip the leads flush.
- Most parts should be mounted as close to the board as possible. Transistors should be mounted about 1/8" above the board. Solder one lead on ICs or IC sockets and then check to make sure the component is flush before soldering the remaining leads.
- Use a Temperature Controlled Soldering Station with small tip or 15-35 watt soldering iron with small tip. Conical or very small screw driver tips are best.
- DO NOT use a large soldering iron or soldering gun.
- If you are a beginner, new to soldering, there are a number of resources on the web to help you get on the right track soldering like a pro. Google Soldering Techniques. Here is one good example:
http://www.elecraft.com/TechNotes/NOSS_SolderNotes/NOSS_SolderNotesV6.pdf

Parts Identification:

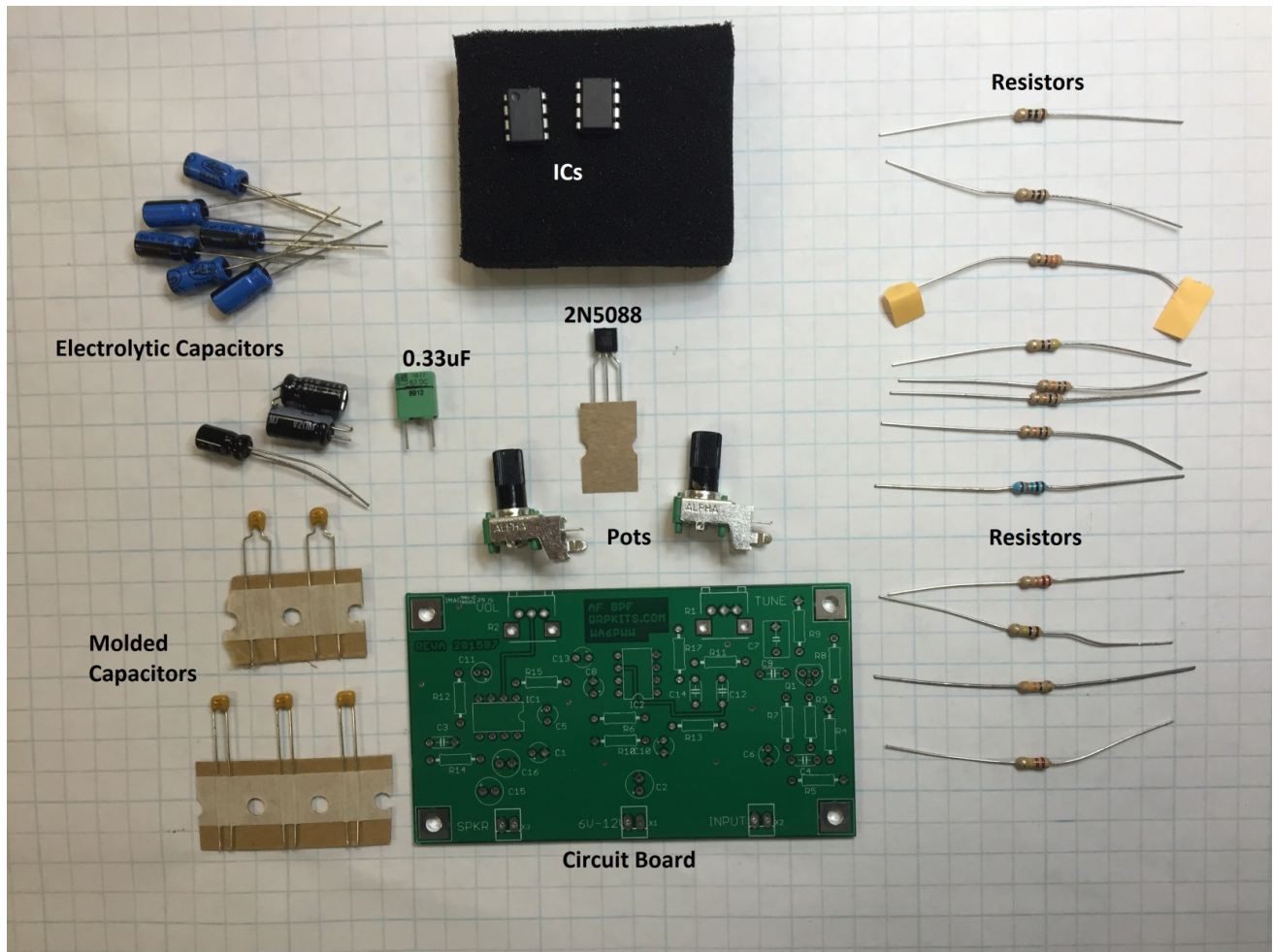

Note: This is a general guide. The parts supplied in the kit may vary slightly in appearance from those shown in this photo and not all parts included in the kit are shown.

Linear Potentiometer R1

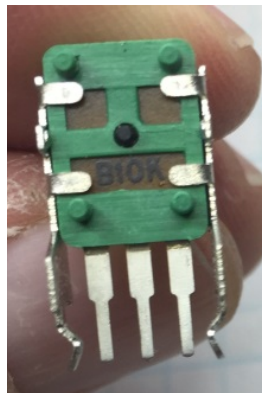

Audio Potentiometer R2

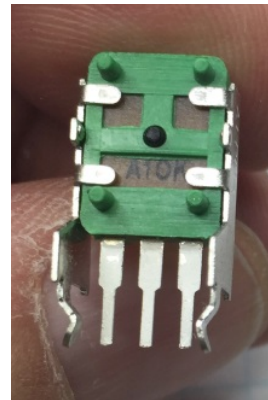

Inventory and Parts List

The first column is for inventory of parts and the second is to track as they are installed

Inventory	Installed	Part	Value	Identification	Description
		R14	10	Brn-blk-blk-gold	10 Ohm 1/4W resistor
		R5	100	Brn-blk-brn-gold	100 Ohm 1/4W resistor
		R17	330	Org-org-brn-gold	330 Ohm 1/4W resistor
		R9	430	Yel-org-brn-gold	430 Ohm 1/4W resistor
		R8	470	Yel-vio-brn-gold	470 Ohm 1/4W resistor
		R7	6.8K	Blu-gry-red-gold	6.8K Ohm 1/4W resistor
		R6	10K	Brn-blk-org-gold	10K Ohm 1/4W resistor
		R10	10K	Brn-blk-org-gold	10K Ohm 1/4W resistor
		R4	15K	Brn-grn-org-gold	15K Ohm 1/4W resistor
		R3	100K	Brn-blk-yel-gold	100K Ohm 1/4W resistor
		R11	100K	Brn-blk-yel-gold	100K Ohm 1/4W resistor
		R13	220K	Red-red-yel-gold	220K Ohm 1/4W resistor
*		R12	*Not Used		
*		R15	*Not Used		
		C9	0.01uF	103	Monolythic capacitor
		C12	0.01uF	103	Monolythic capacitor
		C14	0.01uF	103	Monolythic capacitor
		C3	0.1uF	104	Monolythic capacitor
		C4	0.1uF	104	Monolythic capacitor
		C7	0.33uF	0.33	Rectangular Film Capacitor
		C1	10uF	10uF electrolytic	Round can electrolytic capacitor
		C6	10uF	10uF electrolytic	Round can electrolytic capacitor
		C8	10uF	10uF electrolytic	Round can electrolytic capacitor
		C10	10uF	10uF electrolytic	Round can electrolytic capacitor
		C13	10uF	10uF electrolytic	Round can electrolytic capacitor
		C2	47uF	47uF electrolytic	Round can electrolytic capacitor
		C15	100uf	100uF electrolytic	Round can electrolytic capacitor
		C16	100uf	100uF electrolytic	Round can electrolytic capacitor
*		C5	*Not Used		
*		C11	*Not Used		
		Q1	2N5088	2N5088	Plastic, TO92 Transistor
		Socket	8 pin	8 Pin IC Socket	Black plastic socket for ICs
		Socket	8 pin	8 Pin IC Socket	Black plastic socket for ICs
		IC1	LM386	LM386	8 Pin IC
		IC2	LF356	LF356N	8 Pin IC
		R1	10K linear pot	B10K	9mm square rotary potentiometer
		R2	10K audio pot	A10K	9mm square rotary potentiometer
		Knob	Small Knob	black knob	Tuning knob
		Knob	Small Knob	black knob	Volume knob
		Connector	9V snap	9V battery connector	9V battery snap with leads
		Connector	3.5mm	Audio in	3.5mm audio jack
		Connector	3.5mm	Audio out	3.5mm audio jack
		Wire	3ft	Hookup wire	3 Colors 1 ft each
		PCB	Board	Circuit Board	AF BPF PCB Rev A1 or later

Inserting the Parts

Resistors

Sort the resistors by value insert them smallest value first, largest value last. There are 3 - 10K resistors and one of each of the others. Be sure to check the color code for each resistor as you install. [Measuring with an Ohm meter is a good idea.]

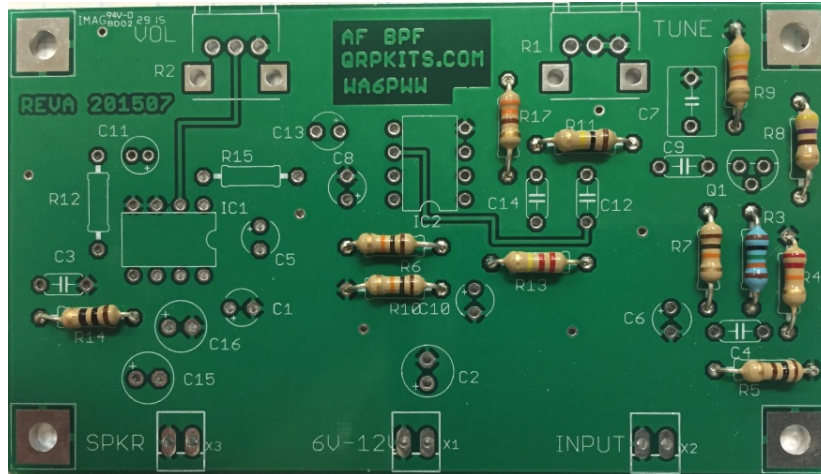

- | | | | |
|--------------------------|-----|------|------------------|
| <input type="checkbox"/> | R14 | 10 | brn-blk-blk-gold |
| <input type="checkbox"/> | R5 | 100 | brn-blk-brn-gold |
| <input type="checkbox"/> | R17 | 330 | org-org-brn-gold |
| <input type="checkbox"/> | R9 | 430 | yel-org-brn-gold |
| <input type="checkbox"/> | R8 | 470 | yel-vio-brn-gold |
| <input type="checkbox"/> | R6 | 10K | brn-blk-org-gold |
| <input type="checkbox"/> | R7 | 6.8K | blu-gry-red-gold |
| <input type="checkbox"/> | R10 | 10K | brn-blk-org-gold |
| <input type="checkbox"/> | R4 | 15K | brn-grn-org-gold |
| <input type="checkbox"/> | R11 | 100K | brn-blk-yel-gold |
| <input type="checkbox"/> | R3 | 100K | brn-blk-yel-gold |
| <input type="checkbox"/> | R13 | 220K | red-red-yel-gold |

Capacitors

Next insert the molded capacitors. There are 3 - 0.01uF, 2 - 0.1uF, and 1 - 0.33uF. The 0.01uF and 0.1uF capacitors look very similar, double check the markings.

- C9 0.01uF 103
- C12 0.01uF 103
- C14 0.01uF 103
- C3 0.1uF 104
- C4 0.1uF 104
- C7 0.33uF 0.33K

Electrolytics

Now insert the electrolytic capacitors. These capacitors are polarized. The negative lead is marked with a black bar on the side of the capacitor.

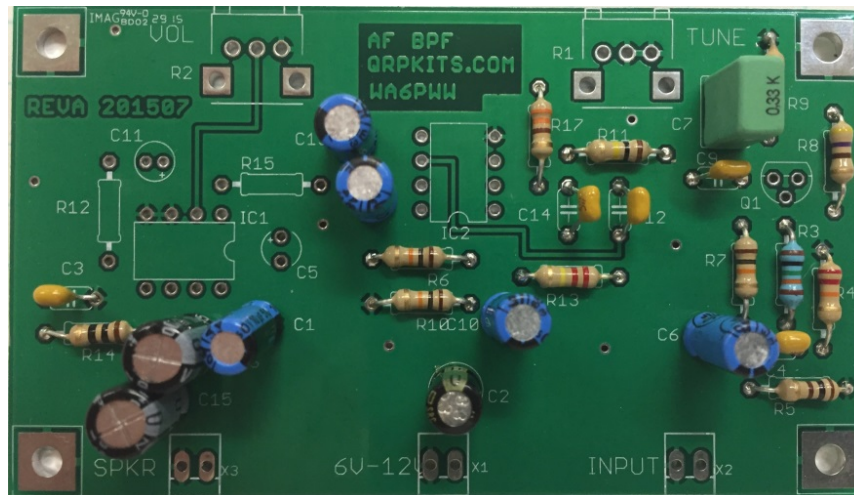

- C1 10uF 10uF
- C6 10uF 10uF
- C8 10uF 10uF
- C10 10uF 10uF
- C13 10uF 10uF
- C2 47uF 47uF
- C15 100uF 100uF
- C16 100uF 100uF

Remaining Parts

Now install Q1 the 2N5088 transistor. Follow the layout orientation on the board. The flat side of the transistor should match the flat side of the diagram.

- Q1 2N5088

Next install the two IC sockets and the ICs. Make sure the orientation notch on the IC matches the orientation notch on the circuit board.

- IC1 LM386
- IC2 LF356

The last 2 parts to install are the two potentiometers. The A10K and B10K identification marks are on the back of the pots and are a bit difficult to read. Use lots of light. Be sure that the B10K pot goes in the spot for R1 and the A10K goes in the location for R2 on the circuit board.

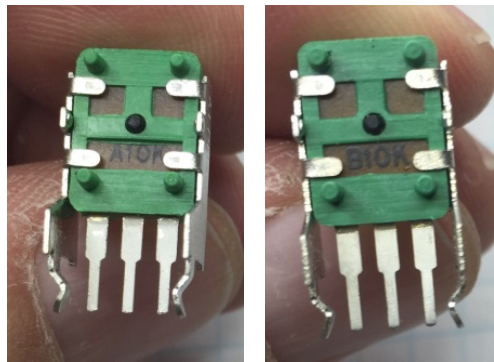

- R1 10K Linear Pot (B) B10K
- R2 10K Audio Pot (A) A10K

Hooking Up the Audio Frequency Band Pass Filter

The ABPF requires 8 - 12V DC. The power may be supplied from a companion kit, a small power supply, or a 9V battery using the battery clip that is included in the kit.

If using an AC operated supply, it should be well regulated and filtered to prevent hum or other noise being added to the audio. An inline fuse of 1A or less is recommended when an AC power supply or 12V battery is used.

Due to the many possible configurations, audio Input and output connections are also left up to the builder. The AFBPF may be wired directly into a receiver or speaker cabinet. Alternatively, the included jacks installed and 3.5mm plugs may be used for input and output connections. The kit is capable of directly driving a small speaker.

When the kit is first powered after assembly, it is recommended to use a battery or connect an inline fuse or a power supply with the current limited to approximately 100-200mA to prevent damage if there are shorts. If you notice large power draw, stop and go back and inspect the board for any shorts or components installed incorrectly.

When the kit is first powered, you should hear static in the speaker or headphones that varies as the volume control is turned. If not, recheck the board for shorts and component errors.

If you have passed this step, you can connect an input audio signal from a receiver or other source of CW signals and you should hear the signal through the output. Moving the tuning knob will place the peak response on the chosen signal.

Packaging

Packaging is left up to the builder. The AFBPF can be built into another kit, or radio cabinet, installed in a speaker cabinet, or installed into a case.

Operation

R1 on the left side of the board is the tuning adjustment, tune to the desired listening frequency by peaking the audible sound on the chosen signal. This will have the affect of amplifying the desired signal while attenuating signals that differ in frequency.

R2 located on the right side of the board is the volume adjustment. Adjust for a comfortable listening level.

If the signals sound distorted, this is likely due to too much audio signal on the input. Reduce the input audio level from the source until the signals sound clean.

Troubleshooting

This is a simple kit and if assembled correctly, it should work without any problems but problems do occasionally happen.

If the kit fails to work, there are a few things to check.

- Verify power supply voltage is at least 8V at the power input.
- Recheck component values, locations and orientations to be sure everything is installed correctly.
- Inspect the board for any missed solder joints, joints that may have not been heated sufficiently or for shorts between adjacent component pads.
- Reheat any suspect solder connections.
- Check input and output connectors for correct wiring.

If these tests do not resolve the problem, contact us at: grpkits.com@gmail.com for further assistance.

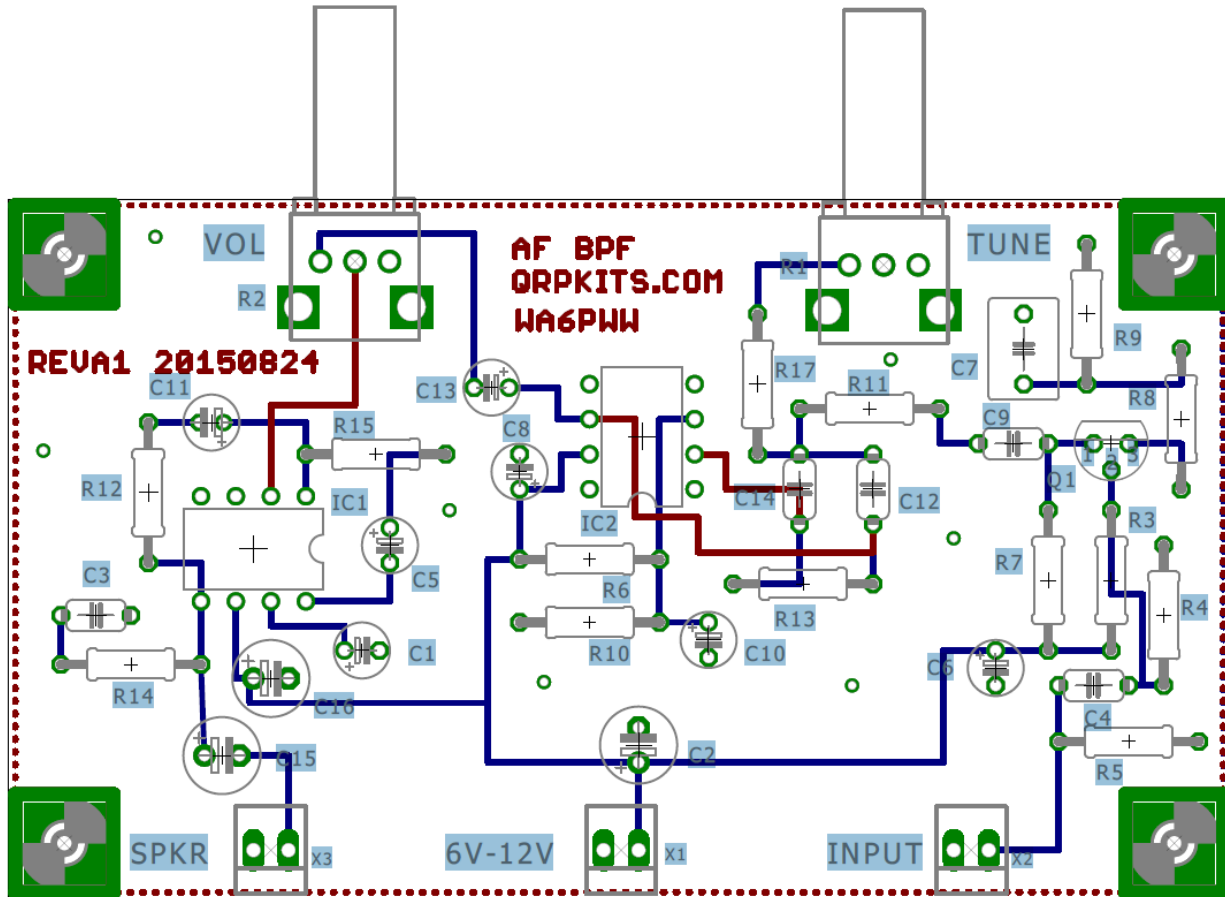

Schematic Diagram

